

Typ 14/65-830 Skater (Art.-Nr. 12000624)
 Type

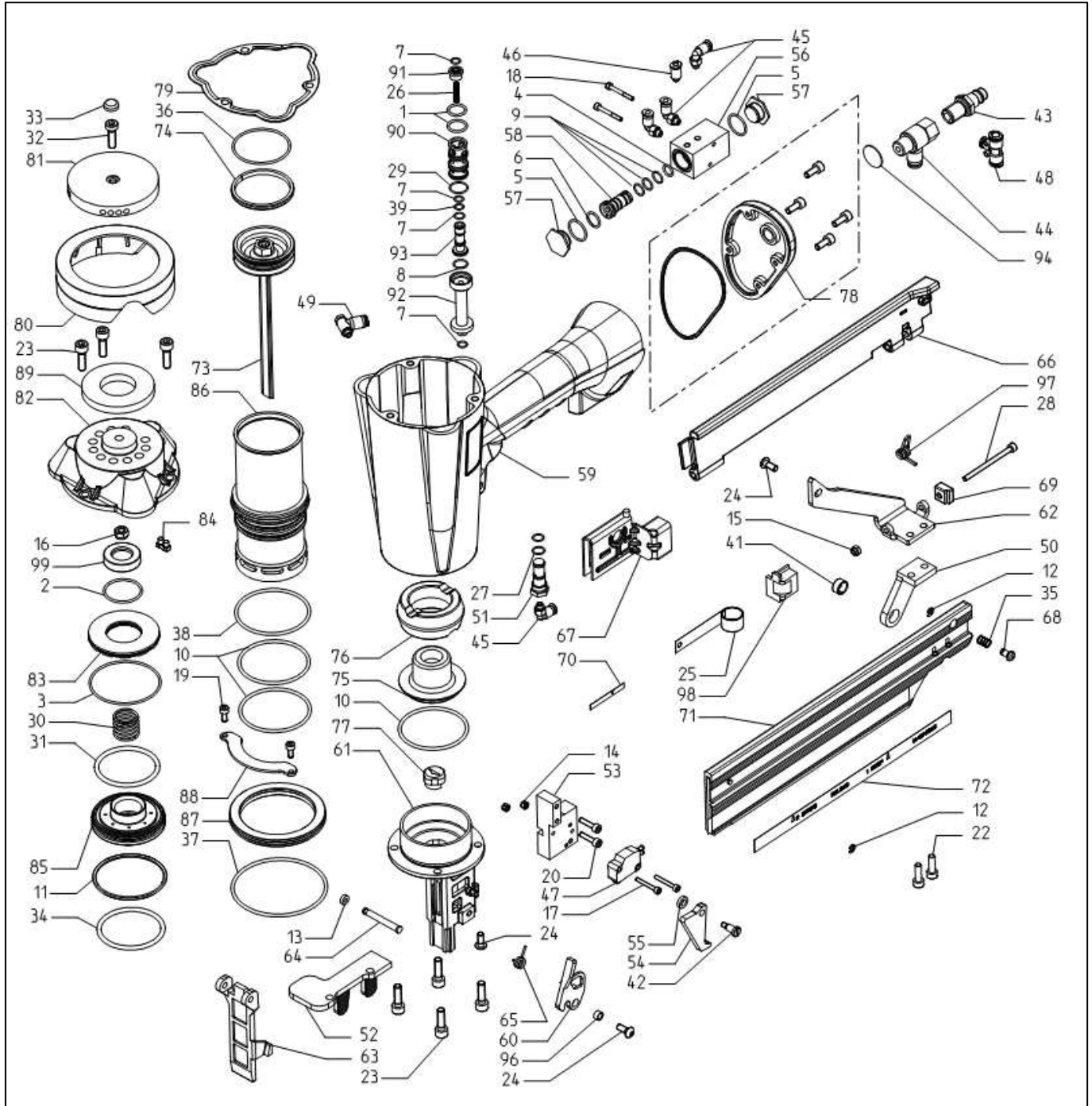

1	O-Ring	13300011			
2	O-ring	13300021			
3		13300029			
4		13300038			
5		13300047			
6		13300048			
7		13300051			
8		13300052			
9		13300063			
10		13300095			
11		13300097			
27		13302647			
29		13302993			
31		13303009			
34		13303030			
36		13303065			
37		13303073			
38		13303074			
39		13303108			
12	Sicherungsscheibe Retaining washer	13300347			
13	Sicherungsring Circlip	13300355			
14	Sicherungsmutter	13300436			
15	Safety nut	13300437			
16		13300439			
17	Zylinderschraube	13301097			
18	Allan screw	13301098			
19		13301103			
20		13301105			
21		13301117			
22		13301118			
23		13301137			
28		13302942			
32		13303014			
24	Linsenschraube Lens head screw	13301352			
25	Rollfeder Roller spring	13301614			
26	Druckfeder	13301775			
30	Compression spring	13302994			
32		13303063			
35		13303063			
33	Schraubenabdeckung Screw Cover	13303015			
41	Gleitlagerbuchse Plain bearing bush	13303887			
42	Passschraube Fitting screw	13303893			
43	Stecknippel Plug-in nipple	14000248			
44	Steckverschraubung	14000288			
45	push-in fitting	14000295			
46		14000297			
48		14001595			
47	Ventil	14001588			
49	Valve	14001601			
50	Winkel Angle	14412310			
51	Ventilbuchse Valve bush	14412366			
52	Auflagewinkel Supporting bracket	14412367			
53	Ventilwinkel Valve angle	14412368			
54	Hebel	14412369			
60	Lever	14404564			
55	Abstandshülse Distance sleeve	14412370			
56	Ventilgehäuse Valve body	14412460			
57	Stopfen	14412461			
84	Post cap	14408670			
58	Steuerkolben	14412462			
93	Piston	14407768			
59	Gehäuse Body	14412501			
61	Kopfstück Nose housing	14409483			
62	Lasche Hook plate	14407738			
63	Kopfstückklappe Nose housing door	14407739			
64	Achse Pin	14407740			
65	Schenkelfeder Leg spring	14408555			
66	Abdeckschiene Cover	14409055			
67	Vorschieber, kompl Pusher, cpl	14409578			
68	Vorschieberarretierung Pusher stop	14408403			
69	Vorschieberanschlag Pusher stop	14409276			
70	Aufkleber Vorschieber Pusher label	14408233			
71	Klammerträger Staple carrier	14407745			
72	Aufkleber Magazin Magazine label	14407891			
73	Kolben, kompl Piston, cpl	14408560			
74	Kolbenring Piston ring	14408612			
75	Puffer 1 Bumper 1	14409228			
76	Puffer 2 Bumper 2	14409229			
77	Treiberführung Driver guide	14407878			
78	Schlagverstärker Booster	14413107			
79	Kappendichtung Cap seal	14407753			
80	Kappenabdeckung Cover	14407765			
81	Luftleitdeckel Air deflector	14407754			
82	Kappe Cap	14408776			
83	Kappenscheibe Cap disc	14407755			
85	Hauptventil Main valve	14408231			
86	Zylinder Cylinder	14409210			
87	Zylinderring Cylinder spacer	14407758			
88	Zylinderabstützung Cylinder spacer	14409211			
89	Schalldämpfer Silencer	14407760			
90	Steuerhülse Socket	14407767			
91	Steuerbuchse Valve bushing	14408250			
92	Zwischenhülse Cylinder, intermediate valve	14407764			
94	Aufkleber OEL 830 Label OIL 830	14408596			
96	Buchse Bushing	14404565			
97	Schenkelfeder Leg spring	14404611			
98	Rollfederführung Support for roller spring	14404616			
99	Scheibe Washer	14407462			